

Alfa Laval Prodec Oil Plus decanter centrifuges

For optimal oil extraction in industrial applications



Application

The Alfa Laval Prodec Oil Plus range of decanter centrifuges was developed specifically for the efficient extraction of oil and fat in industrial processes. Thanks to the unique design, a Prodec Oil Plus decanter enables you to recover virtually all the free oil available in the feed, ensuring maximal utilization of your raw material.

Benefits

Prodec Oil Plus decanter centrifuges are very robust with regard to varying flow conditions and are able to deal with high levels of solids in the feed as well as high fluctuations in oil content – with no need for operator's intervention. They are very easy to operate, and clean using flushing/CIP programs. The oil obtained is exceptionally clean, with very little further processing required.

Key features



UltraOil

Special solids and fluid interaction to gain maximized oil recovery

Decanter design and functionality

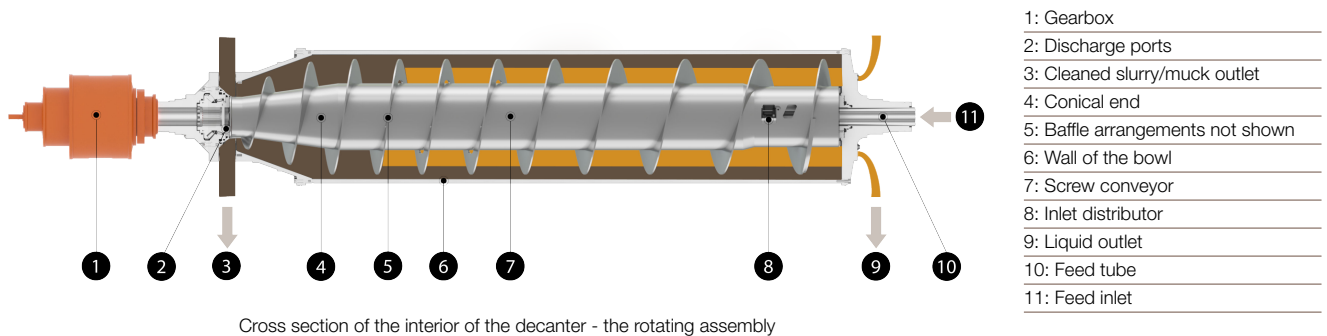

Working principles

The incoming feed is effectively separated into oil (9) and wet solids (3). The product is fed into the bowl through an inlet tube (10) and is accelerated by the inlet rotor (8). Separation takes place in a horizontal cylindrical bowl equipped with a screw conveyor (7) that is purpose-built for efficient oil. Centrifugal force separates the oil from the feed slurry, making the (lower density) oil accumulate at the liquid surface, while the heavier solids settle on the inner wall of the bowl. Oil extraction takes place along the entire length of the cylindrical part of the bowl.

Operating results

The Alfa Laval Oil Plus decanter centrifuge extracts virtually every drop of free oil or fat, with purities as high as 99.5%, with only tiny traces of solids. Skid-mounted test modules are available for renting. Ready to simply plug in and use, these are ideal for testing and demonstrating new operating concepts in an existing application as well as to explore potential new processes.

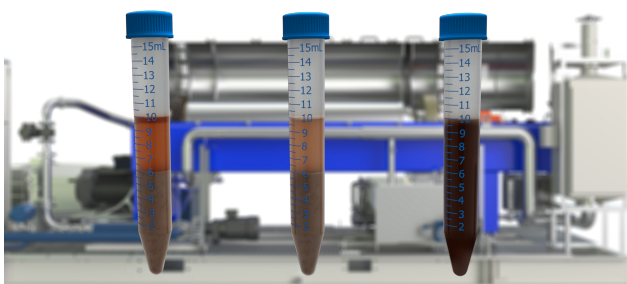

Example
From left: oily feed, oil-free slurry, clean oil

Where to install

The Prodec Oil Plus can be used in a single separation step or in combination with a second decanter. The former setup is recommended where the slurry is normally very wet, and dry solids are not needed.

A 2 stage decanter process is normally recommended when maximum oil extraction, cake dryness and low-fat content in

the final dry solids are the main objective. The Prodec Oil Plus decanter units are easy to integrate into any existing process.

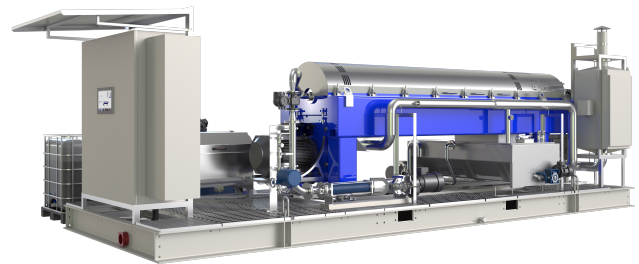

Oil Plus Skid solution

Service

Investing in an Alfa Laval decanter centrifuge gives you access to a Service Agreement that helps boost reliability and maximize uptime when dealing with feed stocks containing particles that cause wear on the bowl and conveyor. We provide service kits that make it easy to carry out service tasks, with skilled Field Service Engineers supporting your exact needs.

Automation

Decanter centrifuges equipped with variable frequency drives (VFD) are available with control solutions to meet specific operating requirements, from basic decanter operations to advanced functionality. Alfa Laval decanter automation can also help you achieve specific process performance goals, along with easy, automated process adjustments, real-time status feedback and automated cleaning cycles.

Connected Services

Decanter centrifuges equipped with automation can be fitted with IoT hardware to streamline data-driven decisions that ensure more uptime and lower cost of ownership. You can then quickly and easily access key Alfa Laval expertise, along with condition monitoring and process optimization. Please refer to the Alfa Laval website for more information.

Selected features

FlightGuard



FlightGuard wear protection consists of tiles welded to the conveyor, providing robust wear resistance and prolonged uptime in highly abrasive applications.

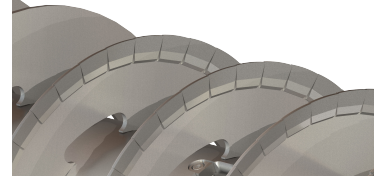

EasyLift



The patented, spring-loaded, hinged design makes it easy to open even the heaviest cover by hand. Offering safe and quick access for maintenance and service.

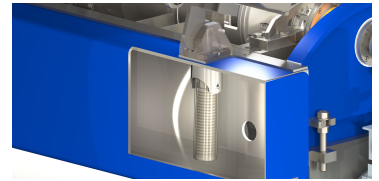

SolidsProtect



The innovative 360° outlet design ensures an even discharge of solids and minimal resistance. The outlet can handle high flow rates without blockages. SolidsProtect outlets feature replaceable wear saddles that maximize reliability and uptime.

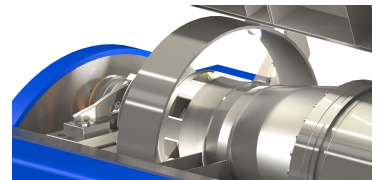

FeedProtect



The uniquely designed FeedProtect feed zone ensures gentle product acceleration and minimal turbulence, resulting in low abrasion and power consumption. The FeedProtect design is equipped with replaceable wear-protection liners, ensuring high uptime.

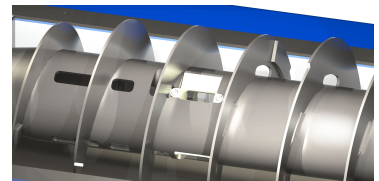

Test module for renting



Skid-mounted test modules are available for renting. Ready to simply plug in and use, these are ideal for testing and demonstrating new operating concepts in an existing application, as well as to explore potential new processes.



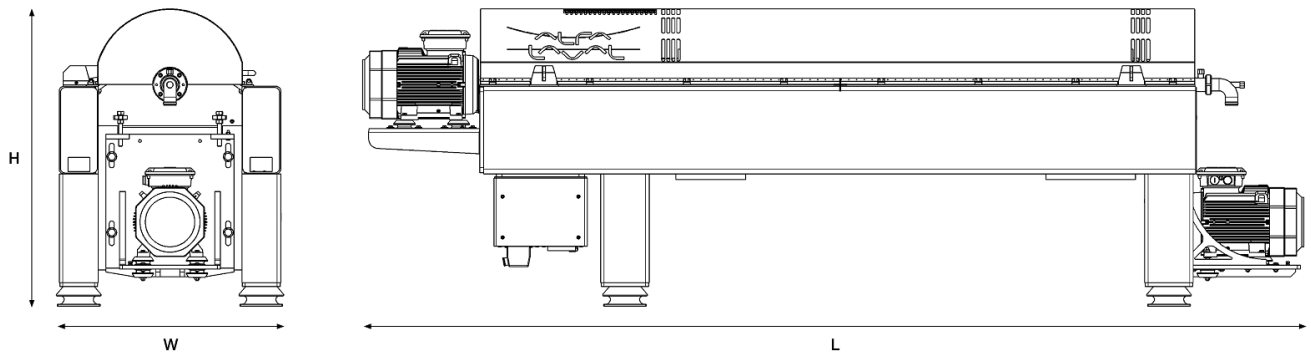

Technical Specification

Designation	Prodec 36 Oil Plus	Prodec 44 Oil Plus	Prodec 50 Oil Plus	Prodec 55 Oil Plus	Prodec 65 Oil Plus
Bowl diameter	360 mm / 14.17 Inc.	440 mm / 17.3 Inc.	500 mm / 19.69 Inc.	550 mm / 21.65 Inc.	650 mm / 25.59 Inc.
Gross weight	2450 kg / 5401 lbs.	3700 kg / 8157 lbs.	4950 kg / 10913 lbs.	5400 kg / 11905 lbs.	7200kg / 15873 lbs.
Length (L)	4558 mm / 179.45 Inc.	5189 mm / 204.29 Inc.	5976 mm / 235.28 Inc.	5722 mm / 225.27 Inc.	6382 mm / 251.25 Inc.
Width (W)	990 mm / 38.98 Inc.	1060 mm / 42 Inc.	1140 mm / 44.88 Inc.	1300 mm / 51.18 Inc.	1450 mm / 57.08 Inc.
Height (H)	1304 mm / 51.34 Inc.	1376 mm / 54 Inc.	1528 mm / 60.16 Inc.	1693 mm / 77.28 Inc.	2381 mm / 93.74 Inc.
Gearbox size	DD 3.5 kNm	DD 3.5 kNm	DD 8 kNm	DD 12 kNm	DD 12 kNm
Total installed power	43 kW / 58 hp	52 kW / 70 hp	60or70 kW / 80or94 hp	77 kW / 103 hp	120or140 kW / 161or188 hp

Additional info

Cover with hinge info:

Please consult the dimensional drawing when defining the area needed around the decanter for opening the cover

Drain Zone:

Individual/specific connection, please consult the dimensional drawing

This document and its contents are subject to copyrights and other intellectual property rights owned by Alfa Laval AB (publ) or any of its affiliates (jointly "Alfa Laval"). No part of this document may be copied, re-produced or transmitted in any form or by any means, or for any purpose, without Alfa Laval's prior express written permission. Information and services provided in this document are made as a benefit and service to the user, and no representations or warranties are made about the accuracy or suitability of this information and these services for any purpose. All rights are reserved.

How to contact Alfa Laval

Up-to-date Alfa Laval contact details for all countries are always available on our website at www.alfalaval.com